

NIMBUS[®]3
NIMBUS[®]3 PROFESSIONAL
Instructions For Use

ARJOHUNTLEIGH
GETINGE GROUP



Contents

General Safety	iii
Introduction	1
About this Manual	1
About Nimbus 3 and Nimbus 3 Professional	1
Nimbus 3 Pump	2
Nimbus 3 Mattress	3
Nimbus 3 Professional Mattress	4
Clinical Applications	6
Indications	6
Contraindications	6
Cautions	6
Care of the patient when sitting	6
Installation	7
Preparing the Nimbus 3 and Nimbus 3 Professional Systems for Use	7
Installing the Nimbus 3 or Nimbus 3 Professional Mattress	7
Installing the Pump	9
Connecting the Tubeset	10
Disconnecting the Tubeset	10
System Operation	10
Controls, Alarms and Indicators	11
Pump Controls	11
Pump Indicators	12
Mattress Controls	14
Additional Controls on the Nimbus 3 Professional Mattress	14
Operation	16
Installing the System	16
Inflating the Mattress	16
Testing the Power Fail Alarm	16
Deflating the Mattress	17
System Optimisation	18
Selecting the Operating Mode	18
Silencing Audible Alarms	19
Comfort Control	19
Transport Control	19
CPR Control	20
Patient Positioning Guidance for the Nimbus 3 Professional Mattress	21
Decontamination	23
Routine Maintenance	25
Nimbus 3 and Nimbus 3 Professional Systems	25
Nimbus 3 Pump	25
Nimbus 3 and Nimbus 3 Professional Mattresses	25

Serial Number Labels	26
Troubleshooting	27
Technical Description	28
Pump	28
Accessories	29
Mattress	29
Cover Specification	30
Cleaning Symbols	31

GENERAL SAFETY

Before you connect the system pump to a mains socket, read carefully all the installation instructions contained within this manual.

The system has been designed to comply with regulatory safety standards including:

- EN60601-1:1990/A13:1996 and IEC 60601-1:1988/A2:1995
- UL60601-1, UL2601-1 and CAN/CSA C22.2 No. 601.1-M90

Safety Warnings

- **It is the responsibility of the care giver to ensure that the user can use this product safely.**
- **Whilst the patient is unattended, safety sides should be used based on clinical assessment and in line with local policy.**
- **Alignment of the bed frame, safety sides and the mattress should leave no gap wide enough to entrap a patient's head or body, or to allow egress to occur in a hazardous manner where entanglement with the mains power cable and tubeset or air hoses may result. Care should be exercised to prevent occurrence of gaps by compression or movement of the mattress. Death or serious injury may occur.**
- **Make sure that the mains power cable and tubeset or air hoses are positioned to avoid causing a trip or other hazard, and are clear of moving bed mechanisms or other possible entrapment areas. Where cable management flaps are provided along the sides of the mattress, these should be used to cover the mains power cable.**
- **Electrical equipment may be hazardous if misused. There are no user-serviceable parts inside the pump. The pump's case must only be removed by authorised technical personnel. No modification of this equipment is allowed.**
- **The mains power socket/plug must be accessible at all times. To disconnect the pump completely from the electricity supply, remove the plug from the mains power socket.**
- **The CPR control and/or the CPR indicator tag must be visible and accessible at all times.**
- **Disconnect the pump from the mains power socket before cleaning and inspecting.**
- **Keep the pump away from sources of liquids and do not immerse in water.**
- **Do not use the pump in the presence of uncontained flammable liquids or gasses.**
- **The cover of this product is vapour permeable but not air permeable and may present a suffocation risk.**
- **Only the pump and mattress combination as indicated by ArjoHuntleigh should be used. The correct function of the product cannot be guaranteed if incorrect pump and mattress combinations are used.**
- **To avoid the risk of electric shock, this equipment must only be connected to a supply mains with protective earth.**
- **Due to the inherently lower flame retardancy of the high performance eVENT^{®1} fabric, it is NOT suitable for use in the homecare environment.**

Precautions

For your own safety and the safety of the equipment, always take the following precautions:

1. eVENT[®] is a registered trademark of BHA Technologies Inc.

- Placing extra layers between the patient and the mattress potentially reduces the benefits provided by the mattress and should be avoided or kept to a minimum. As part of sensible pressure area care, it is advisable to avoid wearing clothing which may cause areas of localised high pressure due to creases, seams, etc. Placing objects in pockets should be avoided for the same reason.
- Do not expose the system, especially the mattress, to naked flames, such as cigarettes, etc.
- In the event of a fire, a leak in the seat or mattress could propagate the fire.
- Do not store the system in direct sunlight.
- Do not use phenol-based solutions to clean the system.
- Make sure the system is clean and dry prior to use or storage.
- Never use sharp objects or electrically heated under blankets on or under the system.
- Store the pump and mattress in the protective bags supplied.

Electromagnetic Compatibility (EMC)

This product complies with the requirements of applicable EMC Standards. Medical electrical equipment needs special precautions regarding EMC and needs to be installed in accordance with the following instructions:

- The use of accessories not specified by the manufacturer may result in increased emissions by, or decreased immunity of, the equipment, affecting its performance.
- Portable and mobile radio frequency (RF) communications equipment (e.g. mobile/cell phones) can affect medical electrical equipment.
- If this equipment needs to be used adjacent to other electrical equipment, normal operation must be checked before use.
- For detailed EMC information contact ArjoHuntleigh service personnel.

Environmental Protection

Incorrect disposal of this equipment and its component parts, particularly batteries or other electrical components, may produce substances that are hazardous to the environment. To minimise these hazards, contact ArjoHuntleigh for information on correct disposal.

Service Information

ArjoHuntleigh recommend that this system should be serviced every 12 calendar months or, where applicable, when the service indicator is illuminated.

Design Policy and Copyright

® and ™ are trademarks belonging to the ArjoHuntleigh group of companies. As our policy is one of continuous improvement, we reserve the right to modify designs without prior notice.

© ArjoHuntleigh 2009.

1. Introduction

About this Manual

This manual is your introduction to the **Nimbus® 3** and **Nimbus 3 Professional** systems. Use it to initially set up the system, and keep it as a reference for day-to-day routines and as a guide to maintenance.

About Nimbus 3 and Nimbus 3 Professional

Nimbus 3 and Nimbus 3 Professional are Dynamic Flotation Systems for the prevention, treatment and management of pressure ulcers.

Nimbus 3 and Nimbus 3 Professional systems comprise a pump and mattress replacement which can be used on standard hospital and normal domestic beds. Beds can be adjusted or profiled with the mattress in position.

The **Nimbus 3 Professional** mattress has the following additional features to enable the patient to be prone, and to assist with pressure area and patient care management:

- A Head Section Deflate Control to allow the three head cells to be fully deflated.
- Individual Vent Valves to allow 16 of the 20 cells to be independently deflated.

The **Nimbus 3 and Nimbus 3 Professional** mattresses incorporate an advanced **AutoMatt®** sensor pad which makes sure that the patient is automatically supported at optimum pressures regardless of size, height, position or weight distribution.

If cardiac arrest occurs, the **Nimbus 3 and Nimbus 3 Professional** mattresses can be deflated in less than 10 seconds to allow cardiac resuscitation procedures to be performed.

Nimbus 3 Pump The same pump is used on the **Nimbus 3** and **Nimbus 3 Professional** systems.

The pump comprises a moulded case with non-slip feet on the base and rear, and an integral carry handle.

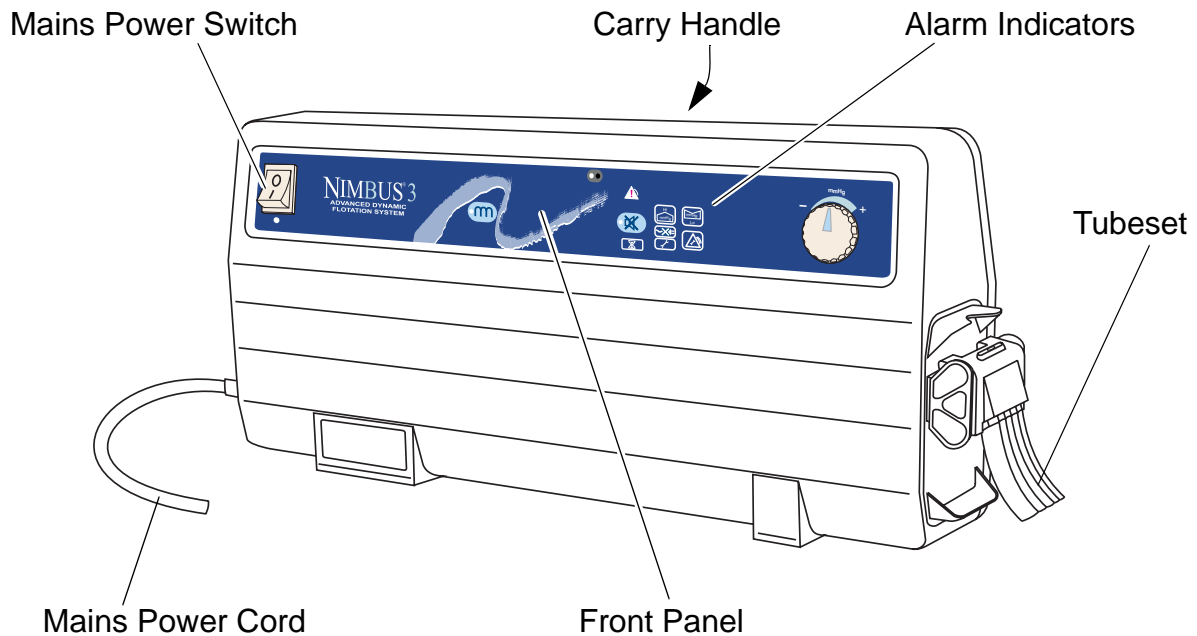

The pump has two modes of operation:

- **Dynamic** mode that cycles the support surface beneath the patient every 10 minutes providing periods of pressure relief for the whole body.
- **Static** mode where the support surface remains constant (all cells equally inflated).

The controls and indicators are located on the front panel, and a sophisticated alarm system differentiates between normal operation and genuine system faults. If an alarm situation is detected a flashing indicator will illuminate, together with an indication of the cause of alarm, and an audible warning will sound.

The pump can be fixed to the foot end of a hospital bed by the separate bed bracket. The bed bracket fits in the pump handle and then clips onto most common bed frames. The pump can also be stood on the floor, either upright or on its rear cover.

Nimbus 3 Mattress The **Nimbus 3** mattress comprises the following components:

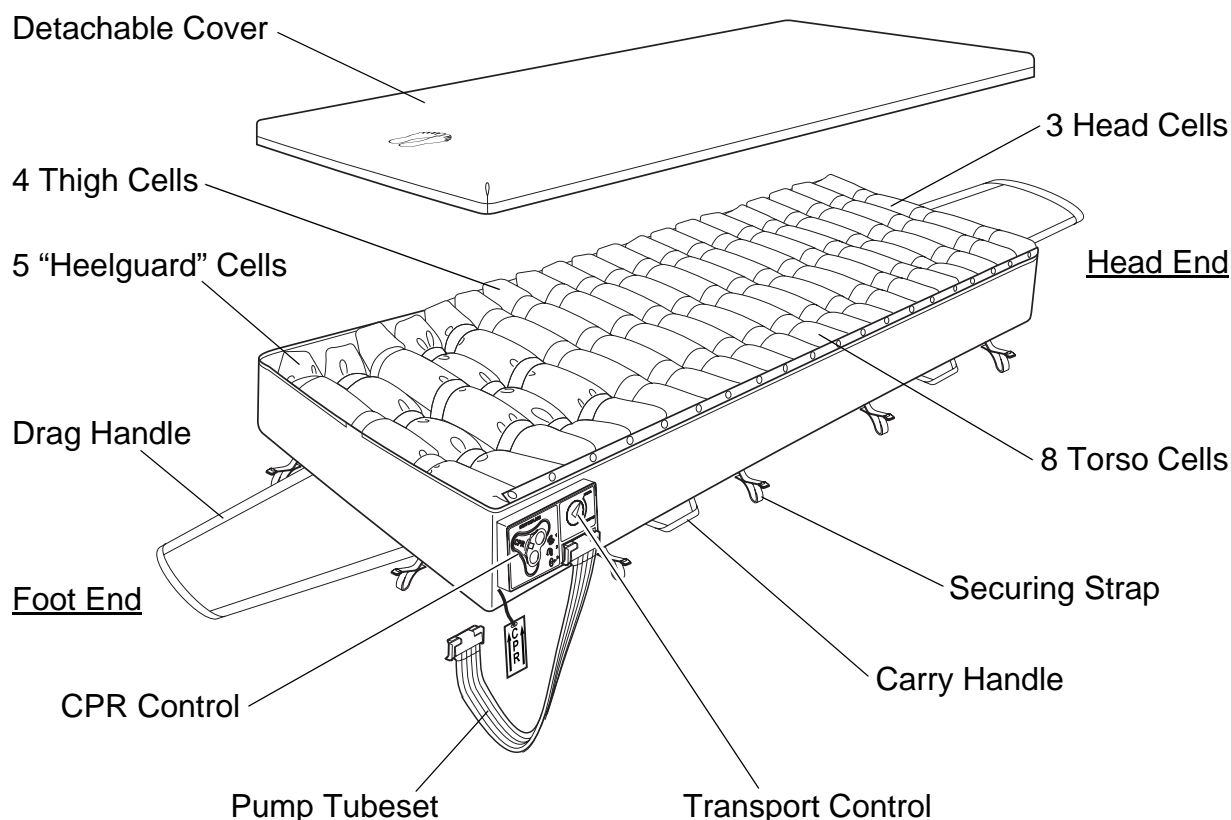

Detachable Cover The standard protective cover comprises a 2-way stretch cover zipped to a durable anti-slip base. The zips are protected by flaps to prevent ingress of contaminants, and allow easy removal of the cover for cleaning. Alternative covers with advanced properties, such as Advantex[®] and eVENT[®], are also available (Refer to “Cover Specification” on page 30).

Cells The **Nimbus 3** mattress comprises 20 polyurethane (PU) cells providing support to the user in either Alternating or Static modes. The cells are grouped in four sections, each of which has a specific function:

- The three Head cells remain at a constant pressure for pillow stability and patient comfort.
- The eight Torso cells combine alternating and static pressure characteristics to support patients fully in both lying and sitting positions without the risk of ‘bottoming’.
- The four Thigh cells cycle dynamically to maximise pressure relief.
- The five **Heelguard**[®] cells are specially powered to maximise the pressure relief under the heels.

AutoMatt The advanced **AutoMatt** sensor pad is under the cells, and makes sure that the patient is automatically supported at optimum pressures regardless of size, height, position or weight distribution.

CPR Control The CPR (Cardio-Pulmonary Resuscitation) Control is at the foot end of the mattress, and allows the air to be evacuated in under 10 seconds.

Transport Control The Transport Control is next to the CPR Control. When operated, it seals the mattress so that air is not exhausted when the tubeset is disconnected and also creates an even pressure in all the cells.

Tubeset The tubeset incorporates a flexible, compact anti-kink tube that is resistant to crushing and any subsequent obstruction of air flow. Each end has a quick-lock system for easily connecting and disconnecting the air supply at the pump and mattress.

Nimbus 3 Professional Mattress

The **Nimbus 3 Professional** mattress is of similar construction to the **Nimbus 3** mattress, with the addition of a Head Section Deflate Control, individual Vent Valves on 16 of the 20 cells and a Shoulder Support Cell.

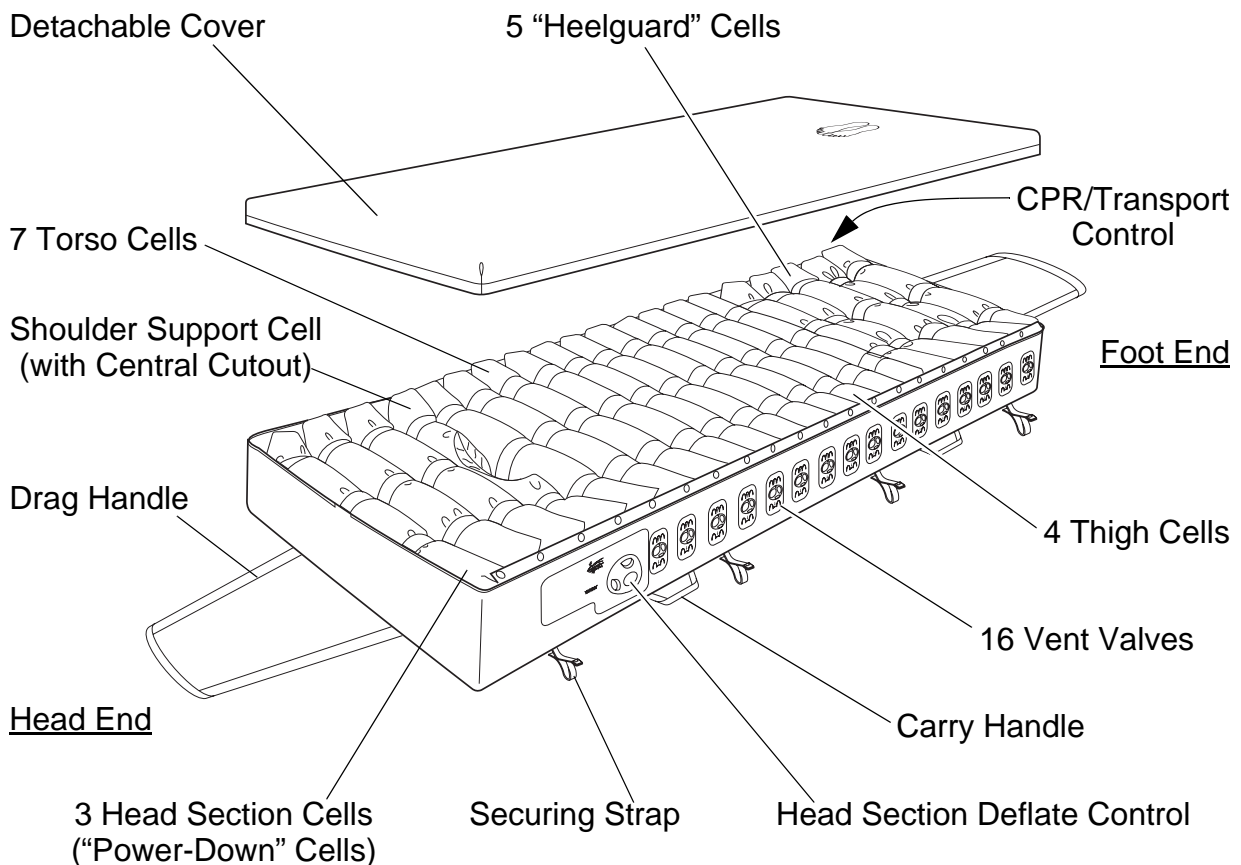

- Head Section Deflate Control** This is a two-position rotary-action control at the head end of the mattress:
- **Dynamic (Normal) Mode.** The three cells in the Head Section are inflated at a constant pressure and the remaining 17 cells alternate.
 - **TriCell Head Section Deflate.** The three cells in the Head Section are fully deflated to assist with patient care management, and the Shoulder Support Cell (the fourth cell, next to the Head Section) is inflated to a constant pressure to support the patient's shoulders. The remaining 16 cells alternate.
- Cells** The **Nimbus 3 Professional** mattress has the same number of cells as the **Nimbus 3** mattress (20 cells). The function of the first four cells at the head end of the mattress is different on the **Nimbus 3 Professional**:
- The three cells in the Head Section are either fully inflated or fully deflated, depending on the position of the Head Deflate Control, to assist with patient care management. The cells are specially powered to enable them to be fully deflated.
 - The single Shoulder Support Cell (the fourth cell, next to the Head Section) has a shallow cutout in the mid-section of the cell. This is to allow access to the neck area for clinical procedures and to ensure the smooth, uniform extension of the neck during deflation. Its operation is controlled by the Head Section Deflate Control: the cell is either fully inflated to support the patient's shoulders or alternates (together with the remaining 16 cells).
 - The remaining 16 cells (seven Torso cells, four Thigh cells and five **Heelguard** cells) have the same basic function as on the **Nimbus 3** mattress.
- Vent Valves** The seven Torso cells, four Thigh cells and five **Heelguard** cells have individual Vent Valves to allow each cell to be independently deflated, to assist with pressure area and patient care management.

2. Clinical Applications

Indications The **Nimbus 3** and **Nimbus 3 Professional** systems are indicated for the prevention and management of all categories¹ of pressure ulcer when combined with an individualised monitoring, repositioning and wound care programme.

The **Nimbus 3** and **Nimbus 3 Professional** mattress is designed for patients weighing up to 250 kg (550 lb).

The **Nimbus 3** and **Nimbus 3 Professional** cushion is designed for patients weighing up to 250 kg (550 lb).

Contraindications Do not use **Nimbus 3** and **Nimbus 3 Professional** systems for patients with unstable spinal fractures.

Cautions If patients have other unstable fractures, or conditions which may be complicated by a soft or moving surface, advice should be sought from an appropriate clinician before use.

While the **Nimbus 3** and **Nimbus 3 Professional** systems have been designed to manage patients up to the weight limits indicated above, those approaching this upper limit are likely to have additional care and mobility needs and may be better suited to a specialist bariatric system.

Active therapy (alternating) cushions may be unsuitable for patients with poor sitting posture or pelvic deformity; advice from a seating specialist should be sought.

Care of the patient when sitting Seated patients are at increased risk of pressure ulcers particularly if they are immobile or have wounds over the seating area. For optimal outcome, provide a pressure redistributing seat cushion in a chair which promotes a good sitting posture and has a level base seat to support the cushion, in addition to an individualised repositioning programme.

 *The above are guidelines only and should not replace clinical judgement.*

*The **Nimbus 3** and **Nimbus 3 Professional** systems represent one aspect of a pressure ulcer management strategy; if existing wounds do not improve or the patients condition changes the overall therapy regimen should be reviewed by the prescribing clinician.*

Mattress and cushion combinations may have different upper weight limits. Cushions should be used in combination with pressure-redistributing mattresses to provide 24-hour therapy.

1. NPUAP/EPUAP International Pressure Ulcer Guideline, 2009.

3. Installation

The **Nimbus 3** and **Nimbus 3 Professional** systems are very simple to install using the following guidelines.

 Refer to Section 4, Page 11 “Controls, Alarms and Indicators” for a comprehensive description of the controls and indicators on the pump and mattress.

Preparing the Nimbus 3 and Nimbus 3 Professional Systems for Use

1. Remove the system from the packaging. You should have the following items:
 - **Nimbus 3** pump, with integral mains power cord.
 - **Nimbus 3** mattress replacement or the **Nimbus 3 Professional** mattress replacement.
 - Bed bracket.
 - Tubeset.

Installing the Nimbus 3 or Nimbus 3 Professional Mattress

1. Remove the conventional mattress from the bed frame and check that there are no protruding bed springs or sharp objects on the bed frame surface.

 *Heavily ridged bed baseboards may require special considerations for correct system operation - consult your ArjoHuntleigh representative.*

2. Unroll the mattress onto the bed base and make sure that the CPR is at the foot end, and the CPR label is hanging freely.
3. Attach the mattress to the bed frame using the hook and loop securing straps.

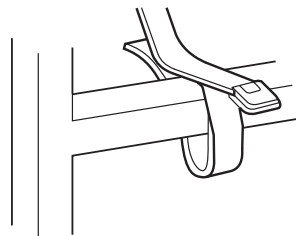

 *If the bed can be profiled to any position (i.e. raised or lowered), attach the mattress to the movable parts of the bed only.*

4. For **Nimbus 3** mattresses only, check the **AutoMatt** sensor pad, as follows:
 - Unzip the cover on one side of the mattress only.
 - Pull the side of the mattress away from the cells.
 - The **AutoMatt** sensor pad is situated under the cells between the soft and hard foam sheets.
 - Make sure that the **AutoMatt** sensor pad is lying flat and is not “kinked”.
 - Zip the cover back onto the mattress, taking care not to trap any cell material in the zip.

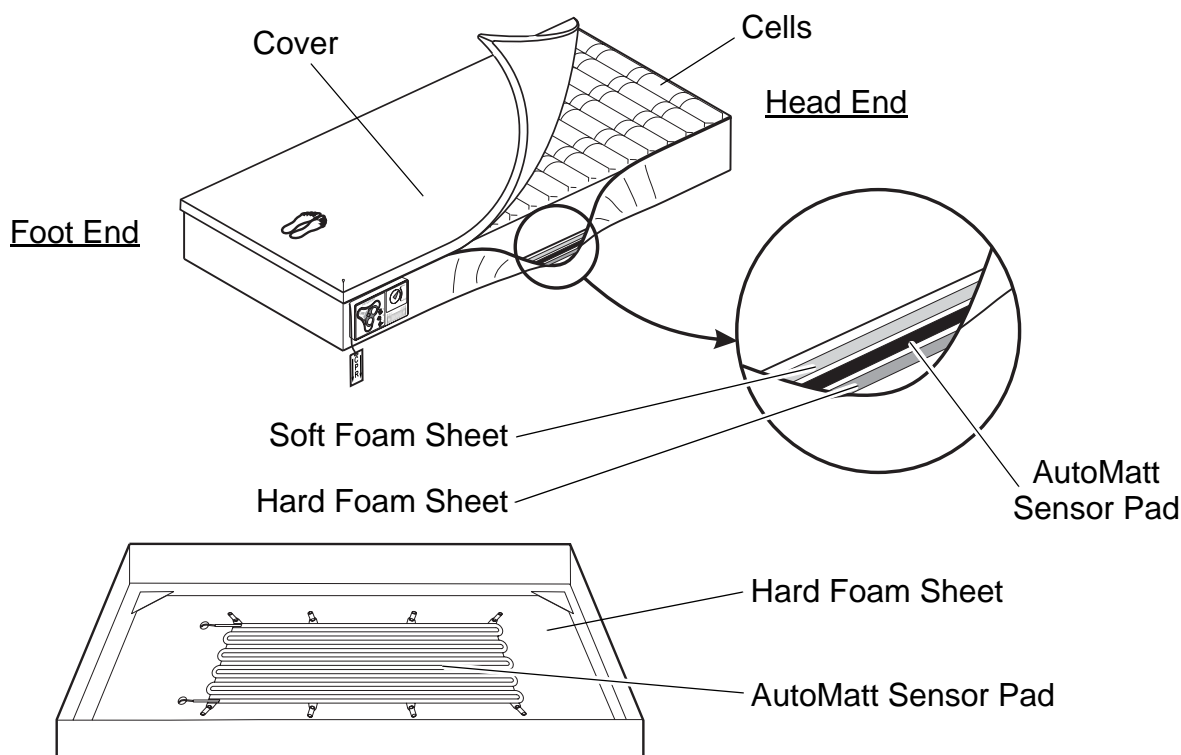

*For **Nimbus 3 Professional** mattresses, the **AutoMatt** is encapsulated and does not need to be checked.*

5. Leave the ends of the mattress cover free when profiling the bed.
6. Make sure the CPR control is closed and locked in position and the Transport control is set to **NORMAL**.

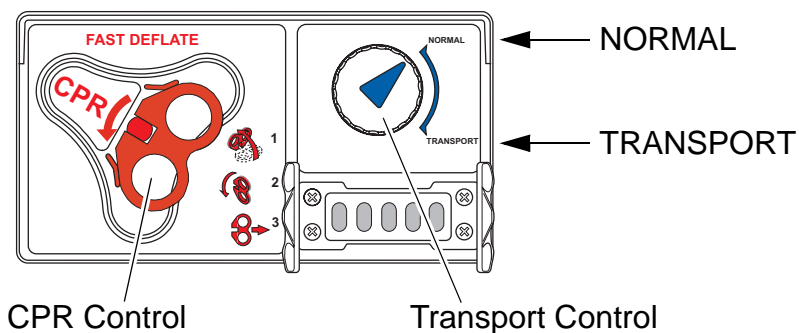

**Additional Checks on
the Nimbus 3
Professional Mattress**

1. Make sure that all 16 Vent Valves are closed.

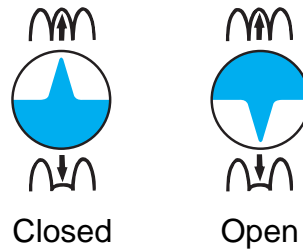

2. Make sure that the Head Section Deflate Control is set to **Dynamic (Normal) Mode**.

TriCell Head Section Deflate

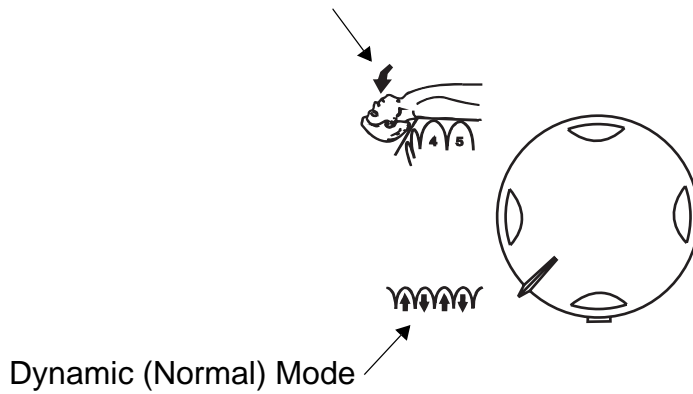

Installing the Pump

1. If the pump is to be hung from the end of the bed, make sure that the bed bracket is securely attached to the pump, and then attach the pump and bed bracket to the bed frame.

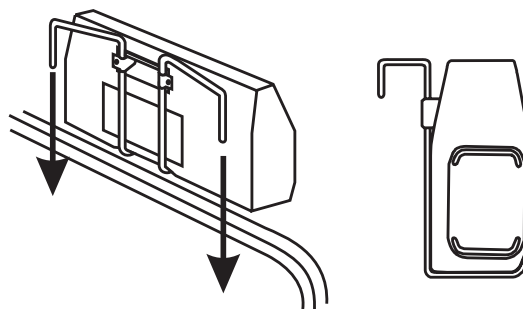

2. Alternatively the pump can be placed underneath the bed, either upright or lying on its back.
3. Insert the connector on the end of the mains power cord into a suitable mains power outlet.

Connecting the Tubeset

To connect the tubeset to the mattress and pump:

1. Locate the bottom of the tubeset connector onto the bottom of the pump/mattress connector.
2. Pull the top of the tubeset connector up and over the top of the pump/mattress connector, until the tubeset connector “clicks” into position.
3. Make sure both connections are secure.

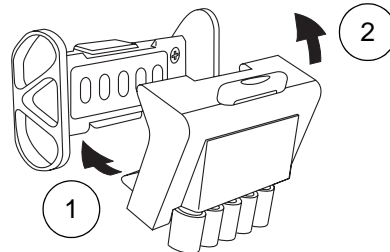

Disconnecting the Tubeset

To disconnect the tubeset from the mattress and pump:

1. Move the tubeset connector down by pulling the tubeset extrusion downwards, and then pull the bottom of the tubeset connector away from the bottom of the pump/mattress connector.
2. Lift the top of the tubeset connector off the top of the pump/mattress connector.

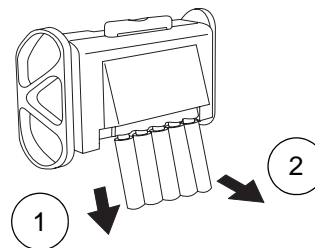

System Operation

The system is now ready for use. Refer to Section 4, Page 11 “Controls, Alarms and Indicators” and Section 5, Page 16 “Operation” for day-to-day operating instructions.

WARNING

Make sure the mains power cord and tubeset are positioned to avoid causing a hazard.

Caution

Make sure the mains power cord and tubeset are clear of moving bed mechanisms or other possible entrapment areas.

4. Controls, Alarms and Indicators

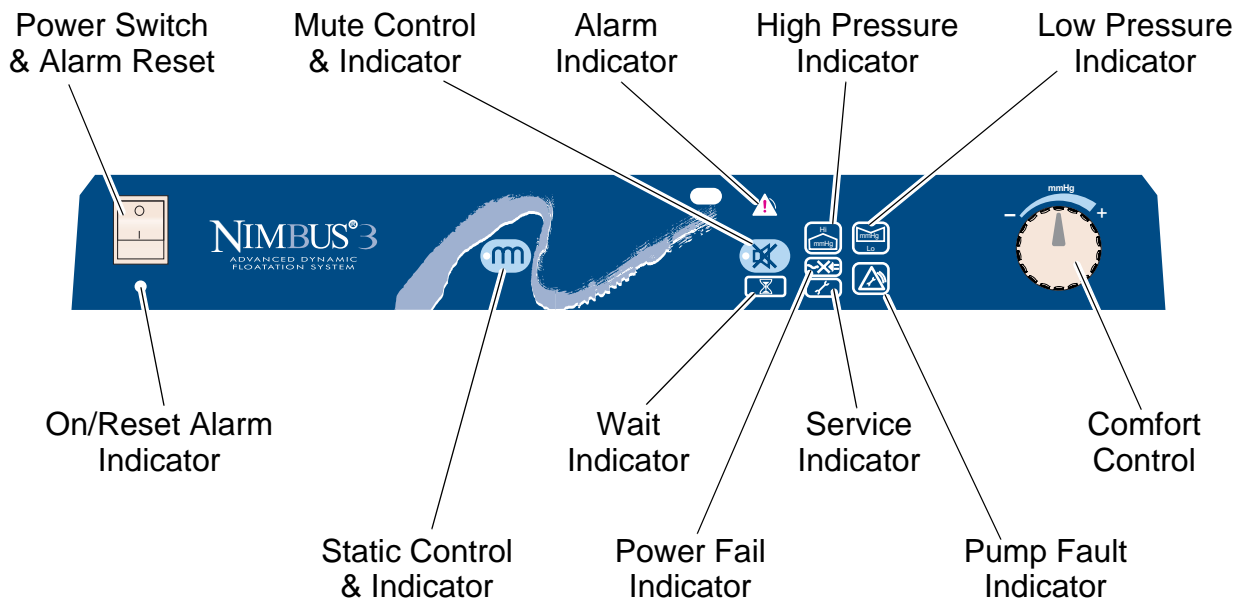

Pump Controls

The pump front panel has the following controls:

POWER Switch (and RESET ALARM)

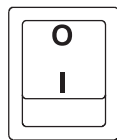

Switches the mains power to the pump on and off.

The green indicator is illuminated when the mains power is connected and the pump switched on.

The switch is also used to reset the pump after an alarm condition has been detected.

STATIC Mode



Selects the operating mode, either **Static** or **Dynamic**. **Static** mode is confirmed when the yellow indicator on the button is illuminated.

When **Dynamic** mode (default) is selected the yellow indicator will be extinguished.

Alarm MUTE



An audible alarm mute is provided to cancel warning sounds during an alarm condition.

COMFORT CONTROL

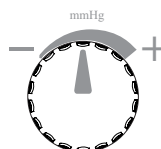

This is a rotary action control to set the relative firmness/softness of the mattress for patient comfort.

Pump Indicators The pump front panel has the following indicators:

ON / RESET ALARM The green **ON / RESET ALARM** indicator below the **POWER** switch is illuminated when the mains power is connected and the pump switched on.

STATIC Mode The indicator on the **STATIC** button is illuminated when **Static** mode has been selected for operation.

Alarm MUTE The indicator on the **MUTE** button is illuminated when an audible alarm has been silenced.

 *The indicator will **NOT** be illuminated when a Power Fail alarm is muted.*

WAIT The **WAIT** indicator is illuminated when the mattress is being inflated.



The indicator will remain illuminated until the mattress has been fully inflated. This may take up to 15 minutes.

HIGH PRESSURE The **HIGH PRESSURE** indicator is illuminated whenever the pump detects high pressure within the mattress.



If this condition occurs, the air supply from the pump is switched off until normal pressure is detected. After 2 seconds of normal pressure being detected the indicator is switched off and the air supply restarted.

LOW PRESSURE The **LOW PRESSURE** indicator is illuminated whenever the pump detects low pressure within the mattress.



This may indicate that there is insufficient pressure to support a patient or that the Transport control is turned to the **TRANSPORT** position whilst the pump is on and connected to the mattress.

The **LOW PRESSURE** indicator will be switched off once normal pressure is reached.

Alarm The pump unit incorporates a sophisticated alarm detection system that differentiates between patient movement and genuine alarm conditions.



Whenever an alarm condition is detected the red **Alarm** triangle starts flashing together with an indicator of the cause of the alarm. Additionally, an audible warning will sound, which can be cancelled by pressing the **Alarm MUTE** button (Refer to “Alarm MUTE” on page 11).

The triangular **Alarm** symbol is displayed with one or more of the following indicators:

- **LOW PRESSURE** (Refer to “LOW PRESSURE” on page 12).
- **HIGH PRESSURE** (Refer to “HIGH PRESSURE” on page 12).
- **PUMP FAULT** (Refer to “PUMP FAULT” on page 13).
- **POWER** (Refer to “POWER Fail” on page 13).



*For all alarm conditions except **Power Fail**, once the alarm condition has been detected and displayed, it can only be cancelled by switching the pump unit off and then back on.*

Refer to Section 8, Page 27 “Troubleshooting” for possible causes of the above alarm conditions.

PUMP FAULT



The **PUMP FAULT** indicator is illuminated when an internal pump malfunction is detected.

The fault can only be rectified by carrying out a service on the pump.

POWER Fail



The **POWER** indicator will flash when a mains power failure has been detected.

The alarm will continue until the mains power is resumed or the pump is switched off using the **POWER** switch on the pump control panel.

Service Indicator



The  symbol will be illuminated after a set number of running hours to indicate that the pump is ready for a service.

This service period is set to 12 months.



The pump will continue to operate normally even when the  symbol is illuminated.

Mattress Controls All **Nimbus 3** and **Nimbus 3 Professional** mattresses have the following two controls, situated at the foot end of the mattress:

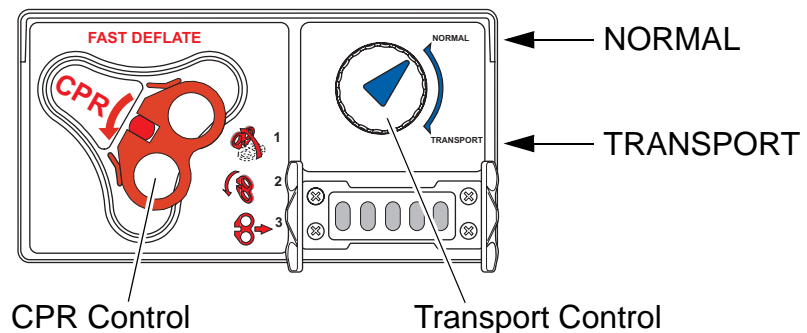

Transport Control This sets the mattress into **TRANSPORT** mode where the support surface is equally pressurised and the pump and tubeset can be removed. In this mode the mattress will support the patient for up to 12 hours.

CPR Control The CPR (Cardio-Pulmonary Resuscitation) Control provides a means of rapidly deflating the mattress to allow normal resuscitation procedures to be carried out.

 *The CPR control is used to deflate the mattress for packing and storage.*

Additional Controls on the Nimbus 3 Professional Mattress

The following two controls are on the opposite side of the mattress to the CPR/Transport Control:

Head Section Deflate Control This is a two-position rotary-action control at the head end of the mattress:

- **Dynamic (Normal) Mode.** The three cells in the Head Section are inflated at a constant pressure and the remaining 17 cells alternate.
- **TriCell Head Section Deflate.** The three cells in the Head Section are fully deflated to assist with patient care management, and the Shoulder Support Cell (next to the Head Section) is inflated to a constant

pressure to support the patient's shoulders. The remaining 16 cells alternate.

TriCell Head Section Deflate

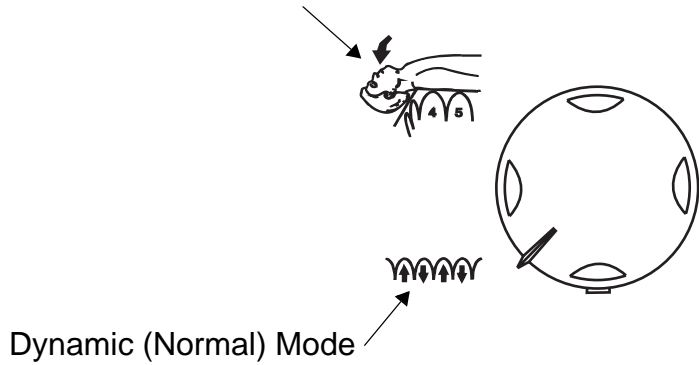

16 Vent Valves The seven Torso cells, four Thigh cells and five **Heelguard** cells have individual Vent Valves to allow each cell to be independently deflated, to assist with pressure area and patient care management.

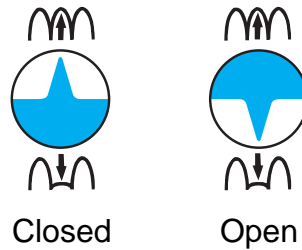

5. Operation

These instructions cover day-to-day operation of the system. Other operations, such as maintenance and repair, should only be carried out by suitably qualified personnel.

 Refer to Section 4, Page 11 “Controls, Alarms and Indicators” for a comprehensive description of the controls and indicators on the pump and mattress.

Installing the System Before using the **Nimbus 3** or **Nimbus 3 Professional** system make sure:

1. The system has been installed correctly in accordance with Section 3, Page 7 “Installation”.
2. The CPR unit on the mattress is closed and locked in position.
3. The Transport control on the mattress is set to **NORMAL**.
4. If a **Nimbus 3 Professional** system is being installed, make sure that on the mattress:
 - All 16 Vent Valves are closed.
 - The Head Section Deflate Control is set to **Dynamic (Normal) Mode**.

Inflating the Mattress

1. Switch the pump **POWER** switch to **ON**. The **ON / RESET ALARM** indicator below the **POWER** switch should illuminate.
2. The pump will now run a self test for approximately 3 seconds when all the indicators on the front panel will be illuminated.
3. If the pump detects low pressure (e.g. a deflated mattress) it will enter an inflation sequence with the **LOW PRESSURE** and **WAIT** indicators illuminated.
4. Once normal operating pressure has been reached both the **LOW PRESSURE** and **WAIT** lights will extinguish.

 It may take up to 15 minutes to inflate the mattress.

The three Head Section cells and the five Heelguard cells will inflate more slowly than the rest of the mattress.

Testing the Power Fail Alarm The Power Fail Alarm is powered by a rechargeable battery. The duration of the alarm will depend on the level of charge in the battery.

The battery may have become discharged or reached the end of its life. It is therefore recommended that the alarm is tested before the pump is used, as follows.

1. Connect the pump to the mains power supply, switch **ON** and allow it to run for 10-15 seconds.
2. Remove the mains power at the wall socket *without* switching the pump off.
3. The power fail alarm should operate within 10 seconds, as follows:
 - The red **Alarm** triangle will flash.
 - The **POWER** indicator will flash.
 - An audible warning will sound.
4. The alarm will continue until the mains power is resumed or the pump is switched off using the **POWER** switch on the pump control panel.
5. If the alarm does not operate, run the pump for approximately four hours to recharge the battery.
6. Retest the alarm after the battery has been recharged. Allow the alarm to operate for approximately two minutes to ensure that it has been adequately recharged.
7. If the alarm does not operate for two minutes, call the service engineer.



If the Power Fail Alarm does not operate after this test and a service engineer has been called, the pump can continue to be used with regular checks of the Power-On status.

All other alarms will continue to function as normal.

Deflating the Mattress

To deflate and store the mattress, do the following:

1. Switch off the pump, and disconnect the pump from the mains power supply.
2. Remove the tubeset from the pump and mattress (Refer to “Disconnecting the Tubeset” on page 10).
3. Activate the CPR control.
4. Make sure the Transport control is set to **NORMAL**.
5. Roll up the mattress, starting at the foot end.



Make sure the mattress is dry before rolling it up.

System Optimisation The **Nimbus 3** and **Nimbus 3 Professional** systems automatically compensate for patient weight distribution and position, to optimise the pressure relieving performance.

 *To make sure that the pressure relieving properties are not impaired, the mattress cover must not be pulled tight and covering sheets should fit loosely using the attached clips.*

The system provides two modes of operation:

- **Dynamic** mode provides the optimum pressure relieving performance and should be used in most cases. In **Dynamic** mode the support surface beneath the patient is cycled every 10 minutes.
- **Static** mode provides a stable, non-moving support surface for instances where a dynamic support surface is contra-indicated. In **Static** mode the support surface remains constant (all cells are equally inflated).

***Nimbus 3 Professional
Mattress only***

On the **Nimbus 3 Professional** system, the following therapeutic positioning controls along the side of the mattress offer further operating modes in combination with the **Dynamic** pressure relief option, to assist with pressure area and patient care management:

1. Head Section Deflate Control. This controls the three cells in the Head Section:
 - **Dynamic (Normal) Mode**, where the three Head cells are inflated at a constant pressure and the remaining 17 cells alternate.
 - **TriCell Head Section Deflate**, where the three Head cells are fully deflated, and the Shoulder Support Cell is inflated to a constant pressure to support the patient's shoulders. The remaining 16 cells alternate.
2. 16 Vent Valves.
The seven Torso cells, four Thigh cells and five **Heelguard** cells have individual Vent Valves to allow each cell to be independently deflated.

**Selecting the
Operating Mode**

- The pump defaults to the **Dynamic** operating mode when switched on.
- Both **Static** and **Dynamic** modes of operation are selected by the **STATIC** button on the front panel.
- When **Static** mode is selected the indicator on the **STATIC** button illuminates.

To change the operating mode:

1. To select **Static** mode from **Dynamic** mode press the **STATIC** button once. An audible tone will sound and the indicator on the button will illuminate to show that the system is in **Static** mode.
2. To select **Dynamic** mode from **Static** mode press the **STATIC** button once. An audible tone will sound and the indicator on the button will extinguish.

Silencing Audible Alarms

Audible alarms can be silenced using the **MUTE** button. To silence an alarm push the **MUTE** button once (the indicator on the **MUTE** button will remain illuminated).



In its normal operating mode an audible alarm can only be silenced after an alarm has occurred. An internal setting can be used to change the mode of operation so that this button can pre-silence an alarm. Call your service engineer if this option is required.

Comfort Control

The mattress cell pressure can be manually adjusted for patient comfort using the rotary **COMFORT CONTROL**. To change the comfort setting:

- Turn **COMFORT CONTROL** clockwise for a firmer setting and counterclockwise for a softer setting.
- The mattress minimum pressure is maintained at the chosen level.



*The system automatically compensates for patient size, height, position and weight distribution to provide optimum support regardless of the **COMFORT CONTROL** setting.*

Transport Control

This seals the mattress and allows the removal of the pump for patient transport. The patient will remain supported by the mattress for up to 12 hours in **Transport** mode. To set the **Transport** mode:

1. At the foot end of the mattress turn the Transport control knob clockwise to **TRANSPORT**.
2. Turn the pump off and disconnect the tubeset.



*If the Transport control is set to **TRANSPORT** with the tubeset connected and the pump switched on, then the pump will indicate a **Low Pressure** fault alarm.*

To resume normal operation:

1. Re-connect the pump and tubeset to the mattress.
2. Turn the Transport control knob counterclockwise to **NORMAL**.

CPR Control

IMPORTANT IN THE EVENT OF CARDIAC ARREST.

In the event of a patient suffering cardiac arrest and CPR needing to be administered:

- To Activate the CPR**
1. Lift the red CPR handle at the foot end of the mattress.

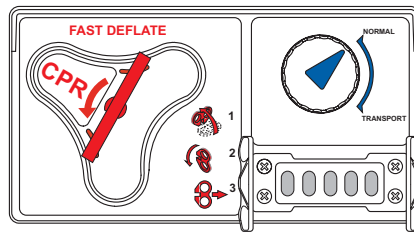
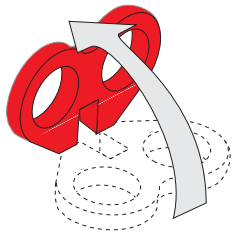

2. Turn the handle counterclockwise.

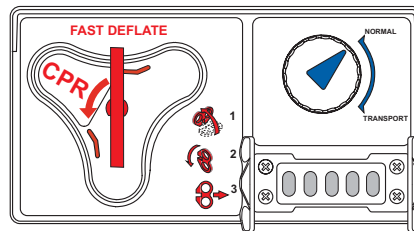
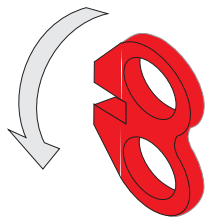

3. Pull the handle away from panel.

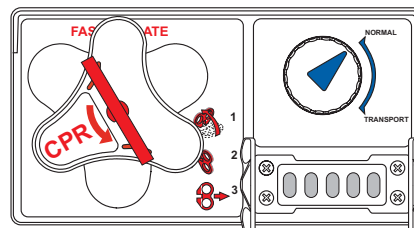
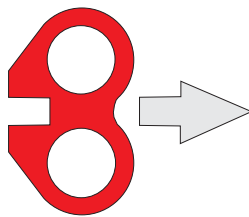

4. The grey triangular seal will rotate and the air will exhaust from the mattress. The torso area of the patient will bottom out in less than 10 seconds.

- To Reset the CPR**
1. Turn the grey triangular seal clockwise and push onto the connectors.
 2. Turn the red handle clockwise.
 3. Fold the handle flat to lock in position.

Patient Positioning Guidance for the Nimbus 3 Professional Mattress

The **Nimbus 3 Professional** mattress allows the patient to be placed in either the Supine or Prone positions.

WARNING

A full patient assessment, as to the suitability for Prone Nursing, is essential before commencing the procedure.

Safety sides should be used where appropriate (Refer to “General Safety” on page iii).

It is important that the patient’s head, neck and shoulders are in the correct anatomical position.

Care should be taken at all times to check that all tubes/lines are positioned correctly.

In the Prone position, regular checks should be made to make sure the patient is free from a build up of pressure on the anatomically sensitive areas such as:

- **Head and facial areas including eyes**
- **Top of the shoulders**
- **Sternum**
- **Breasts and genitals**
- **Knees and toes**

 *It is important for the optimal use of the system that patients are positioned correctly on the mattress.*

1. In both the Supine and Prone positions, patients should be positioned on the mattress so that the tops of their shoulders lie between the third and fourth cells.
2. Supine Position.

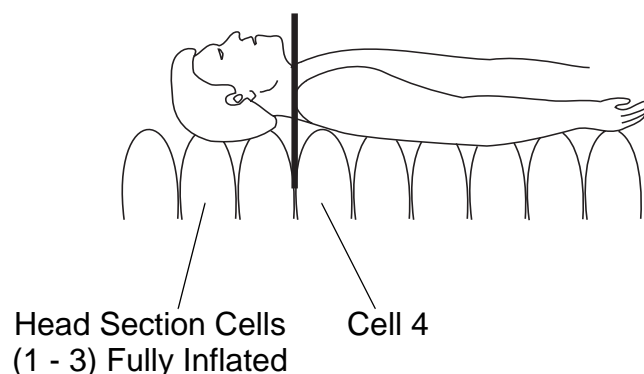

3. Prone Position.

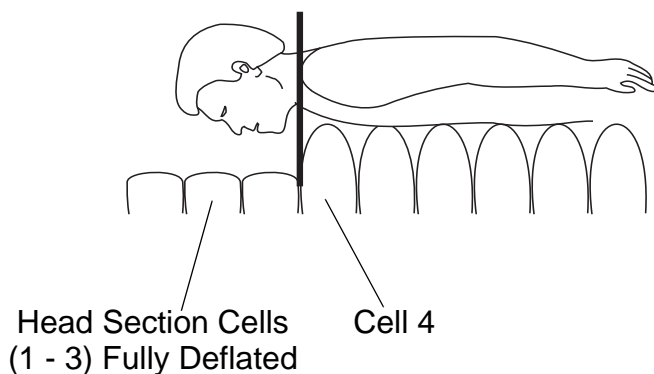

4. It is recommended that a minimum of four staff will be required to turn the patient from the Supine to the Prone position.
 - The anaesthetist or most senior member of the team should be positioned at the head end of the bed and will co-ordinate the turning procedure. This person will also be responsible for the safety of the patient's head, neck and ventilation tubing.
 - The other members of the team will help safeguard all lines, and assist with the turning procedure as directed.

 *Before commencing the turn, it is recommended that all non-essential lines and monitoring equipment are disconnected.*

5. With the patient in the Supine or Prone positions, the mattress controls can be configured as follows:
 - Set the Head Section Deflate Control to **TriCell Head Section Deflate** (where the 3 Head cells are fully deflated, and the Shoulder Support Cell is fully inflated to support the patient's shoulders) which can assist with intubation and insertion of central monitoring lines.
 - Open individual Vent Valves (on the seven Torso cells, four Thigh cells and five **Heelguard** cells) to allow single cell deflation to assist with pressure area care and patient management, including everyday interventions such as CXR imaging.

WARNING

Vent Valve Restrictions. For periods longer than 10 minutes, have no more than 4 cells deflated at any one time (excluding the three cells in the Head Section).

6. Decontamination

The following processes are recommended, but should be adapted to comply with the local or national guidelines (Decontamination of Medical Devices) which may apply within the Healthcare Facility or the country of use. If you are uncertain, you should seek advice from your local Infection Control Specialist.

The **Nimbus 3** and **Nimbus 3 Professional** system should be routinely decontaminated between patients and at regular intervals while in use; as is good practice for all reusable medical devices.

WARNING

Remove the electrical supply to the pump by disconnecting the mains power cord from the mains power supply before cleaning. Protective clothing should always be worn when carrying out decontamination procedures.

Caution

Do not use Phenol-based solutions or abrasive compounds or pads during the decontamination process as these will damage the surface coating. Do not boil or autoclave the cover. Avoid immersing electrical parts in water during the cleaning process. Do not spray cleaning solutions directly onto the pump.

To clean Clean all exposed surfaces and remove any organic debris by wiping with a cloth moistened with a simple (neutral) detergent and water. Dry thoroughly.

Chemical Disinfection To protect the integrity of the cover we recommend a chlorine-releasing agent, such as sodium hypochlorite, at a strength of 1,000ppm available chlorine (this may vary from 250ppm to 10,000ppm depending on local policy and contamination status).

Wipe all cleaned surfaces with the solution, rinse and dry thoroughly.

Alcohol based disinfectants (maximum strength 70%) may be used as an alternative.

Ensure the product is dry before storage.

If an alternative disinfectant is selected from the wide variety available we recommend that suitability for use is confirmed with the chemical supplier prior to use.

DO NOT WRING/MANGLE, AUTOCLAVE OR USE PHENOLIC BASED SOLUTIONS.

Thermal Disinfection For information for the mattress top cover, including laundering guidelines, refer to “Cover Specification” on page 30.

7. Routine Maintenance

Nimbus 3 and Nimbus 3 Professional Systems

Maintenance The equipment has been designed to be virtually maintenance-free between service periods.

Servicing ArjoHuntleigh will make available on request service manuals, component parts lists and other information necessary for ArjoHuntleigh trained personnel to repair the system.

Service Period It is recommended that the pump is serviced every 12 months by an ArjoHuntleigh authorised service agent.

The service symbol  will be illuminated on the pump front panel to indicate that the pump is ready for a service (Refer to “Service Indicator” on page 13).

Nimbus 3 Pump

General Care, Maintenance and Inspection Check all electrical connections and the mains power cord for signs of excessive wear.

Test the Power Fail Alarm before use (Refer to “Testing the Power Fail Alarm” on page 16).

In the event of the pump being subjected to abnormal treatment, e.g. immersed in water or dropped, the unit must be returned to an authorised service centre.

Biofilter The internal biofilter can be run continuously for two years before it requires autoclaving or replacement.

The biofilter can only be replaced by a service engineer.

Nimbus 3 and Nimbus 3 Professional Mattresses

General Care Remove the cover from the mattress.

Inspect the cover for signs of wear or any tears, and check that all cover fasteners are secure.

Check the security of all internal connections, including:

- Between the cells and the manifold.
- To the CPR/Transport Controls.
- To the Head Section Deflate Control on the **Nimbus 3 Professional**.

Make sure all cell fasteners are correctly connected to the mattress base sheet and are not loose or damaged.

Serial Number Labels



Pump The serial number label for the pump is on the back of the pump case.

Mattress The serial number label for the mattress is on the top of the CPR/Transport Control, on the outside of the mattress at the foot end.

8. Troubleshooting

The following table provides a troubleshooting guide for the **Nimbus 3** and **Nimbus 3 Professional** systems in the event of malfunction.

 Refer to Section 4, Page 11 “Controls, Alarms and Indicators” for a comprehensive description of the alarms and indicators on the pump.











Indicator	Possible Cause	Remedy
LOW PRESSURE and WAIT .	<ol style="list-style-type: none"> The pump is inflating the mattress. CPR control not fully closed. 	<ol style="list-style-type: none"> Both indicators will extinguish when the operating pressure is reached. Close CPR control.
LOW PRESSURE .	<ol style="list-style-type: none"> The tubeset is not connected properly. CPR control not fully closed. The Transport control on the mattress is set to TRANSPORT. There is a leak in the system 	<ol style="list-style-type: none"> Check the tubeset connectors and make sure they are securely connected to the pump and mattress. Close CPR control. Turn the Transport control to NORMAL. Call the service engineer.
HIGH PRESSURE .	<ol style="list-style-type: none"> The tubeset is blocked. The AutoMatt sensor pad is blocked. 	<ol style="list-style-type: none"> Check that the tubeset is not kinked. Check that the AutoMatt sensor pad is flat and not kinked.
Flashing POWER and  symbol.	<ol style="list-style-type: none"> Power Fail Alarm.^(a) The pump has detected that mains power has been removed. 	<ol style="list-style-type: none"> Re-apply mains power or switch off the pump using the POWER switch on the control panel. If power failure is prolonged, switch to TRANSPORT mode and disconnect the tubeset. The mattress will remain inflated for 12 hours.
Flashing PUMP FAULT and  symbol.	<ol style="list-style-type: none"> Internal pump malfunction. 	<ol style="list-style-type: none"> Call the service engineer.
 symbol.	<ol style="list-style-type: none"> The pump needs a service.^(b) 	<ol style="list-style-type: none"> Call the service engineer.
Mattress cells will not inflate (Nimbus 3 Professional only).	<ol style="list-style-type: none"> Vent Valves are open. 	<ol style="list-style-type: none"> Close Vent Valves.

- a. If the pump has not been used for a long period, the internal battery which provides the Power Fail Alarm indication may be discharged. Run the pump for a few hours to recharge the internal battery, and the Power Fail Alarm indication will be provided as normal. To check that the Power Fail Alarm is operating correctly, refer to “Testing the Power Fail Alarm” on page 16.

- b. The service period is set to 12 months.

9. Technical Description

PUMP	
Model:	Nimbus 3 / Nimbus 3 Professional
Part Numbers:	151010 (151STD)
Supply Voltage:	230 VAC
Supply Frequency:	50 Hz
Power Input:	35 VA
Size:	508 x 220 x 100 mm (20 x 8.7 x 4")
Weight:	5.7 kg (12.5 lb)
Case Material:	ABS Plastic
Plug Fuse Rating:	5A to BS1362 (UK ONLY)
Pump Fuse Rating:	2 x F500 mA L 250 V
Degree of protection against electric shock:	Mains Connected - Class I Type BF
Degree of protection against liquid ingress:	IPX0
Mode of operation:	Continuous

SYMBOLS							
 (Off)	Power Disconnects from the mains supply		Do not dispose of in domestic refuse		Alternating Current		Dangerous voltage
 (On)	Power Connects to the mains supply		Refer to accompanying documents		Refer to the User Manual		Fuse
	With respect to electric shock, fire and mechanical hazards only in accordance with UL60601-1 and CAN/CSA C22.2 No. 601.1. MEDICAL EQUIPMENT		Type BF	SN:	Serial number	Ref:	Model Number









ENVIRONMENTAL INFORMATION			
Condition	Temperature Range	Relative Humidity	Atmospheric Pressure
Operating	+10°C to +40°C	30% to 75%	700hPa to 1060 hPa
Storage and Transport	-40°C to +70°C	10% to 95% (non-condensing)	500 hPa to 1060 hPa

ACCESSORIES		
Part:	Tube Set	
Part Number:	151200	151201
Length:	1000 mm (39.4")	2500 mm (98.4")
Materials:	Tube: 5-way moulded PVC Connectors: Moulded Nylon	

MATTRESS		
Nimbus 3	Standard Width	Narrow Width
Standard Cover	152010DAR	237010
Advantex® Cover	152010ADV	(not applicable)
Length	2085 mm (82.0")	
Height:	215 mm (8.5")	
Width:	890 mm (35.0")	800 mm (31.5")
Weight:	11.5 kg (25.3 lb.)	10.3 kg (22.7 lb.)
Cell Material:	Polyurethane	
Base Material:	PU Coated Nylon	
Top Cover Material:	PU Coated Fabric or Advantex	PU Coated Fabric
Nimbus 3 Professional	Standard Width	Narrow Width
Standard Cover	412001DAR	412201DAR
Advantex® Cover	412001ADV	412201ADV
eVENT® Fabric Cover	412001EVE	412201EVE
Length	2085 mm (82")	
Height:	215 mm (8.5")	
Width:	890 mm (35.0")	800 mm (31.5")
Weight:	15.5 kg (34.1 lb.)	14.3 kg (31.5 lb.)
Cell Material:	Polyurethane	
Base Material:	PU Coated Nylon	
Top Cover Material:	PU Coated Fabric or Advantex or eVENT Fabric	

COVER SPECIFICATION			
Feature	Standard Cover (Dartex)[®]	Advantex[®]	eVENT[®] Fabric^(a)
Removable Cover	Yes	Yes	Yes
Moisture Vapour Permeable	Yes	Yes	12 times higher
Air Permeable	No	No	Yes
Low Friction	Yes	18% lower	20% lower
Water Resistant / Repellent	Yes	Yes	Yes
Infection Control	Material coating is Bacteriostatic, fungistatic, antimicrobial	Material coating is Bacteriostatic, fungistatic, antimicrobial	INERT MATERIAL does not support bacterial growth
Fire Retardant	BS 7175: 0,1 & 5	BS 7175: 0,1 & 5	BS EN ISO 12952-1 ONLY (a)
2-Way Stretch	Yes	Some	No
Washing Conditions	MAX 95°C (203°F) for 15 mins ^(b)	MAX 95°C (203°F) for 15 mins ^(b)	71°C for 3 minutes or 65°C for 10 minutes
Drying Conditions	Tumble Dry up to 130°C (266°F) or Air Dry	Tumble Dry ONLY at 80-85°C (176°F-185°F)	Tumble Dry up to 130°C (266°F) or Air Dry
Life Span	50 Wash Cycles (minimum)	50 Wash Cycles (minimum)	15 Wash Cycles ^(c)
Application Area	Acute and Homecare	Acute and Homecare	Acute ONLY (a)

- a. Due to the inherently lower flame retardancy of the high performance eVENT[®] fabric, it is **NOT** suitable for use in the homecare environment.
- b. Check your local policy to determine the time/temperature ratio required to achieve thermal disinfection.
- c. The life span of the eVENT cover is significantly lower due to the inherent nature of the eVENT material.

CLEANING SYMBOLS			
	Wash at 71°C (160°F) for a minimum of 3 minutes		Tumble dry at 80-85°C.
	Wash at 95°C (203°F) for a minimum of 15 minutes		Tumble dry at 130°C
	Wash at 65°C (149°F) for a minimum of 10 minutes		Wipe surface with damp cloth
	Do not iron		Use solution diluted to 1000 ppm of Available Chlorine
	Do Not Use Phenol-based cleaning Solutions		

AUSTRALIA

ArjoHuntleigh Pty Ltd
PO Box 330
Hamilton Hill
AU-6963 WESTERN
AUSTRALIA
T: +61 8 9 337 4111
F: +61 8 9 337 9077

AUSTRIA

ArjoHuntleigh GmbH
Dörrstrasse 85
AT-6020 INNSBRUCK
T: +43 512 20 4160-0
F: +43 512 20 4160 75

BELGIUM

ArjoHuntleigh NV/SA
Evenbroekveld 16
B-9420 ERPE MERE
T: +32 (0) 53 60 73 80
F: +32 (0) 53 60 73 81

DENMARK

ArjoHuntleigh A/S
Vassingerødvej 52
DK-3540 LYNGE
T: +45 4 913 8486
F: +45 4 913 8487

FINLAND

ArjoHuntleigh OY
Vanha Porvoontie 229
FI-01380 VANTAA
T: +35 8 9 4730 4320
F: +35 8 9 4730 4999

FRANCE

HNE
451 Chemin de Champivost
BP20
FR-69579 LIMONEST CEDEX
T: +33 (0)4 78 66 62 66
F: +33 (0)4 78 66 62 67

GERMANY

ArjoHuntleigh GmbH
Peter-Sander-Strasse 10
DE-55252 MAINZ-KASTEL
T: +49 6134 1860
F: +49 6134 186 160

ITALY

ArjoHuntleigh S.p.A.
Via Tor Vergata, 432
IT-ROMA 00133
T: +39 06-87426214
F: +39 06-87426222

NETHERLANDS

ArjoHuntleigh BV
Biezenwei 21
NL-4004 MB TIEL
Postbus 6116
NL-4000 HC TIEL
T: +31 (0) 344 64 08 00
F: +31 (0) 344 64 08 85

NEW ZEALAND

ArjoHuntleigh Ltd
Unit 6/38 Eaglehurst Road
Ellerslie
NZ-AUCKLAND
T: +64 9 525 2488
F: +64 9 525 2433

POLAND

ArjoHuntleigh Polska Sp. z.o.o.
ul. Ks. Wawrzyniaka 2
PL-62052 KOMORNIKI
T: +48 61 662 1550
F: +48 61 662 1590

SOUTH AFRICA

Huntleigh Africa Pty Ltd
120 Willem Cruywagen Avenue
Klerksoord
ZA-PRETORIA
T: +27 12 542 4680
F: +27 12 542 4982

SPAIN

ArjoHuntleigh Ibérica S.L.
Carratera de Rubi, 88,
1ª planta-A1
Sant Cugat del Valles
ES-BARCELONA 08173
T: +34 93 583 1120
F: +34 93 583 1122

SWEDEN

ArjoHuntleigh AB
Box 61
S-241 21 ESLÖV
T: +46 413 645 00
F: +46 413 645 83

SWITZERLAND

ArjoHuntleigh AG
Florenzstrasse 1D
CH-BASEL 4023
T: +41 (0) 61 337 97 77
F: +41 (0) 61 311 97 42

UNITED KINGDOM

Huntleigh Healthcare Ltd
310-312 Dallow Road
Luton, Bedfordshire
LU1 1TD
T: +44 (0)1582 413104
F: +44 (0)1582 459100

USA

ArjoHuntleigh
2349 W Lake Street - Suite 250
Addison, IL 60101
T: +1 630 307 2756
Toll Free US: (800) 323 1245
F: +1 630 307 6195

151996EN_04: October 2009

ARJOHUNTLEIGH

GETINGE GROUP

... with people in mind.

Therapy & Prevention Product Division
ArjoHuntleigh, 310-312 Dallow Road, Luton,
Bedfordshire, LU1 1TD, United Kingdom
T: +44 (0)1582 413104 F: +44 (0)1582 459100
W: www.arjohuntleigh.com



93/42/EEC



943447

ArjoHuntleigh is a branch of Arjo Ltd Med AB, Arjo Ltd Med AB Registered No: FC024121
ArjoHuntleigh Registered No: BR010203 England. Registered Office As Above.

MEMBER OF THE GETINGE GROUP